

# Compact pressure switch for multiple actuators

GW...A5  
GW...A5/1

**DUNGS**<sup>®</sup>  
Combustion Controls

5.02

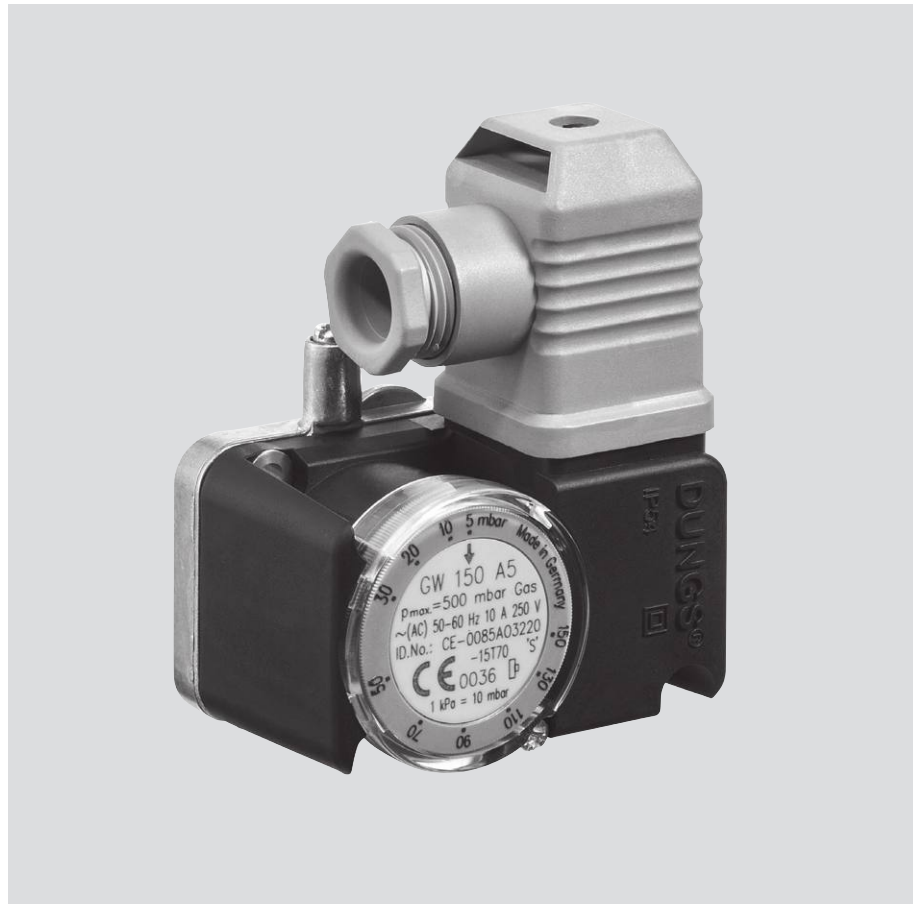

## Technical description

The GW...A5 pressure switch is a compact pressure switch as per EN 1854 for DUNGS multiple actuators.

The pressure switches are suitable for switching a circuit on, off or over on changes in actual pressure relative to the set switching point (reference value).

The switching point can be set easily and quickly using a setting wheel provided with a scale without using a pressure gauge.

## Application

Pressure switches for DUNGS multiple actuators GasMultiBloc and DMV double solenoid valve which can be either mounted directly on housing or by using an adapter.

Suitable for gases of families 1,2,3 and other neutral gaseous media.

## Approvals

EC type testing certificate as per:

- EC-Gas Appliances Regulation
- EC-Pressure Equipment Directive

Pressure switch class "S" as per EN 1854.

Approvals in other important gas-consuming countries.

### Functional description

Single-acting pressure switch in over-pressure range.

The pressure switches operate without any power supply.

### Switching response

#### GW...A5

Short response time during pressure fluctuations.

### GW...A5/1

Slow response time during short-term pressure fluctuations by additional damping nozzle.

### Pressure Switch

The GW...A5 is a single-acting pressure switch acting in pressure range. The control unit responds to pressure.

If the set reference value is exceeded or undershot, the circuit is switched on, off or over.

### Switching function

#### As pressure rises:

1 NC opens, 2 NO closes

#### As pressure falls:

1 NC closes, 2 NO opens

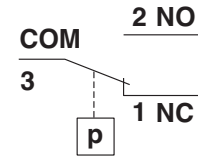

### Specifications

Max. operating pressure	GW 3 A5 - GW 150 A5 GW 500 A5	500 mbar (50 kPa) 600 mbar (60 kPa)		
Pressure connection	O ring flange connection on underside of pressure switch			
Measuring connection	ø 9, length 10 mm, with screw plug			
Temperature range	Ambient temperature Medium temperature Storage temperature	-15 °C to +70 °C -15 °C to +70 °C -30 °C to +80 °C		
Materials	Housing: Switch: Diaphragms: Switching contact:	Aluminium die casting Polyamide NBR Ag		
Switching voltage	AC eff. min. 24 V DC min. 24 V	max. 250 V max. 48 V		
Nominal current	<b>GW 10...500 A5</b> AC eff. max. 10 A	<b>GW 3 A5</b> AC eff. max. 6 A		
Switching current	AC eff. max. 6 A AC eff. max. 3 A AC eff. DC DC	at cos φ 1 at cos φ 0,6 min. 20 mA min. 20 mA max. 1 A	AC eff. max. 4 A AC eff. max. 2 A AC eff. DC DC	at cos φ 1 at cos φ 0,6 min. 20 mA min. 20 mA max. 1 A
Electrical connection	Plug connection for line sockets as per DIN EN 175 301-803, 3-pin, protection insulated without ground connection			
Degree of protection	IP 54 as per IEC 529 (EN 60529)			
Setting tolerance	±15% switching point deviation referred to reference value, adjusted at <b>pressure rises</b> , vertical diaphragm position			
Deviation	Permissible deviation of the set value ≤ ± 15 % in the service life test according to EN 1854			

### Definition of $\Delta p$ switching difference

The  $\Delta p$  switching difference is the pressure difference between the upper and lower switching pressure.

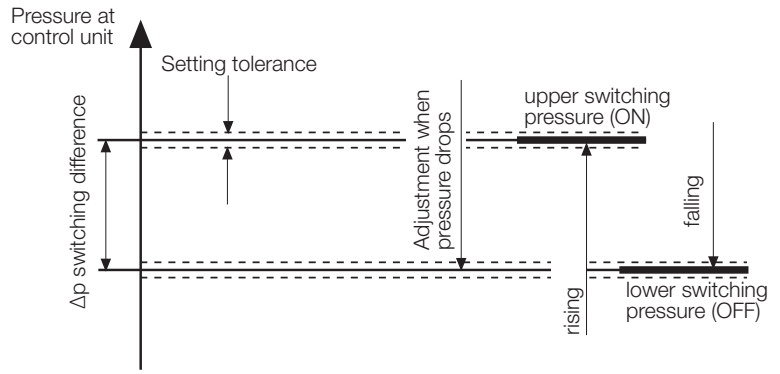

### Switching difference $\Delta p$ @ GW...A5/A6

Depending on the corresponding set value ( $p \downarrow$ )

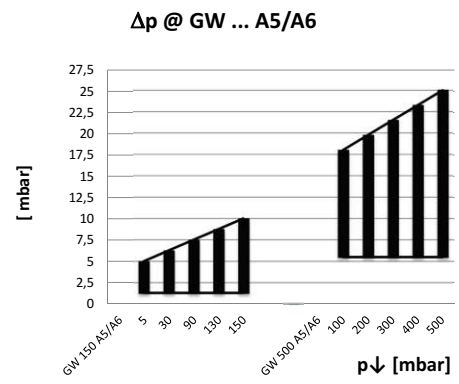
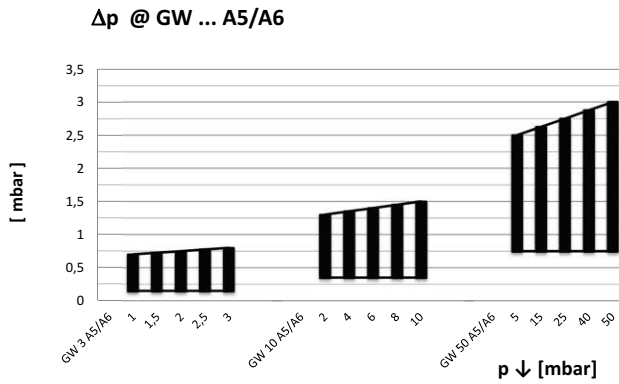

### Installation position



Standard installation position; if different observe the change in switching point:

GW 3...50 A5 max.  $\pm 0,6$  mbar  
 GW 150 A5 max.  $\pm 1$  mbar  
 GW 500 A5 max.  $\pm 3$  mbar



In the horizontal installation position the switching pressure is increased.



When the pressure switch is mounted horizontally overhead, its switching pressure decreases.

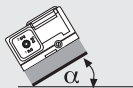

When the pressure switch is mounted in an intermediate position, its switching pressure deviates.

## Dimensions [mm]

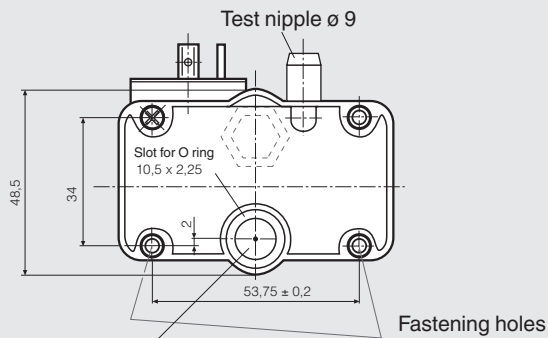

Pressure connection  
optionally with damping nozzle  
for GW...A5/1

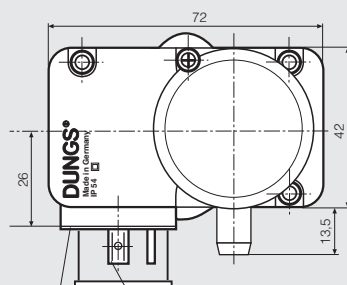
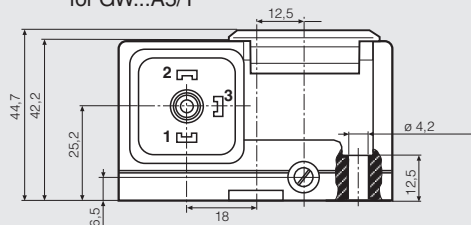

Seal  
Plug connection for line socket as per  
DIN EN 175 301-803

Safety cover for plug-type connection

## Designation

### GW 150 A5 [Ag-G3-MS6-V12]

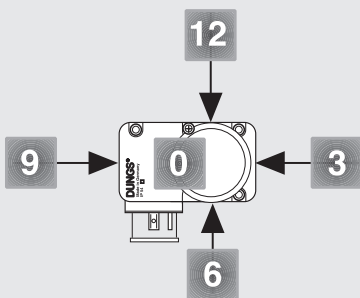

## Order example

### Pressure switch design

Pressure Switch GW...A5

### Setting range

0,5 - 15 kPa (5 - 150 mbar)

### Contact material

Ag

### Electrical connection

Equipment connector

### Pressure connection

At position 12

### Test nipple

MS 6

GW 150 A5 [Ag-G3-MS6-V12]

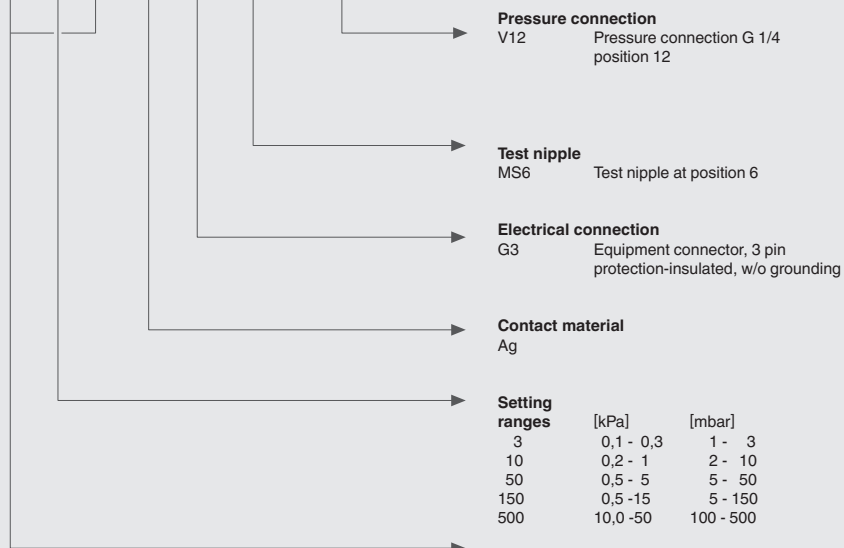

#### Pressure connection

V12 Pressure connection G 1/4 position 12

#### Test nipple

MS6 Test nipple at position 6

#### Electrical connection

G3 Equipment connector, 3 pin protection-insulated, w/o grounding

#### Contact material

Ag

#### Setting ranges



	[kPa]	[mbar]
3	0,1 - 0,3	1 - 3
10	0,2 - 1	2 - 10
50	0,5 - 5	5 - 50
150	0,5 - 15	5 - 150
500	10,0 - 50	100 - 500

#### Pressure switch design

GW...A5 Pressure switch switches when the setpoint is exceeded or undershot.

GW...A5/1 Pressure switch with damping nozzle switches on if the set reference value is exceeded or undershot

**Brief technical data** 1 kPa = 10 mbar = 1000 Pa ≈ 100 mm WS

Type	Version [AG-G3-MS6-V12]	Order No.	Order No.	Setting range		Switching difference $\Delta p$ [mbar]		
		1 piece	100 pieces	[mbar]	max.	p ↓ min.	p ↓ max.	
<b>GW...A5</b> pressure switch	GW 3 A5	<b>272 362</b>	<b>229 250</b>	1 - 3	± 15 %		≤ 0,7	≤ 0,8
	GW 10 A5	<b>272 350</b>	<b>225 938</b>	2 - 10	± 15 %		≤ 1,3	≤ 1,5
	GW 50 A5	<b>272 340</b>	<b>225 939</b>	5 - 50	± 15 %		≤ 2,5	≤ 3
	GW 150 A5	<b>272 339</b>	<b>225 940</b>	5 - 150	± 15 %		≤ 5	≤ 10
	GW 500 A5	<b>272 349</b>	<b>227 639</b>	100 - 500	± 15 %		≤ 18	≤ 25
with mounting kit								
<b>GW...A5</b> pressure switch	GW 50 A5	—	<b>264 873</b>	5 - 50	± 15 %		≤ 2,5	≤ 3
	GW 150 A5	—	<b>264 874</b>	5 - 150	± 15 %		≤ 5	≤ 10
	GW 500 A5	—	<b>264 875</b>	100 - 500	± 15 %		≤ 18	≤ 25
without mounting kit								
<b>GW...A5/1</b> pressure switch	GW 10 A5/1	<b>241 245</b>	—	2 - 10	± 15 %		≤ 1,3	≤ 1,5
	GW 50 A5/1	<b>241 246</b>	—	5 - 50	± 15 %		≤ 2,5	≤ 3
	GW 150 A5/1	<b>241 247</b>	<b>272 363</b>	5 - 150	± 15 %		≤ 5	≤ 10
	GW 500 A5/1	<b>241 248</b>	—	100 - 500	± 15 %		≤ 18	≤ 25
with damping orifice and mounting kit								

Accessories	Order-No.	for Type	Nominal diameters
Mounting kit (2 x M4x20, 1 x O-ring)	223 280		
Adapter $p_{Br}$	273 777	MB-D ...405 - 420 MB-Z ...405 - 420 DMV- ...503 - 520	Rp 3/8 - Rp 2 Rp 3/8 - Rp 2 Rp 3/8 - Rp 2
Adapter on threaded flange (G 1/8)	221 630	MB- ...405-412 DMV- ... SV- ...505-520	Rp 3/8 - Rp 1 1/4 Rp 3/8 - Rp 2
Adapter kit for GW ... A5 with G 1/4 connection	222 982	DMV- ... MB- ...415-420	Rp 3/8 - Rp 2
Special adapter on request		MB- ... DMV- ... MVD- ...	DN 40 - DN 125 Rp 3/8 - DN 150
Line socket 3-pin + E grey GDMW	210 318		

**Compact pressure switch  
for multiple actuators**

**GW...A5  
GW...A5/1**

We reserve the right to make any changes in the interest of technical progress.

**Head Offices and Factory  
Karl Dungs GmbH & Co. KG  
Karl-Dungs-Platz 1  
D-73660 Urbach, Germany  
Telephone +49 (0)7181-804-0  
Telefax +49 (0)7181-804-166**

**Postal address  
Karl Dungs GmbH & Co. KG  
Postfach 12 29  
D-73602 Schorndorf, Germany  
e-mail [info@dungs.com](mailto:info@dungs.com)  
Internet [www.dungs.com](http://www.dungs.com)**